

FUJIFILM

instax mini Evo

HYBRID INSTANT CAMERA

[INSTANT PRINT + DIGITAL TECHNOLOGIES]

User's Guide (Full version)



- This User's Guide (Full version) corresponds to firmware version Ver.1.05. Depending on the firmware version, the functions and screens may differ from those described.
- There are two methods to upgrade the firmware. For details, refer to [FIRMWARE UPGRADE].(p. 22)

Table of Contents

Before Use.....	3	Various Shots.....	17
Notes on Disposing of the Camera	3	Changing the Brightness of the Image.....	17
About This Camera	3	Using the Self-Timer to Take Photos.....	17
Main Features	3	Taking Photos with the Flash.....	18
Functions Available with the Smartphone Application	3	Taking Macro Photos.....	18
Part Names.....	4	Matching the Light Source when Taking Photos	19
LCD Screen display	6	Taking a Photo of Yourself (Selfie)	19
Using the Select buttons.....	7	Using AF/AE Lock to Take Photos	20
Attaching the Shoulder Strap	7	Printing from Print History	20
Charging the Battery	8	Using the Memory Card	21
Charging Status Indication	8	Inserting a Memory Card.....	21
Power On/Off.....	8	Using the Shooting Menu	22
How to Check the Battery Level	9	Using the PLAYBACK MENU.....	23
Configure the initial settings.....	9	Smartphone App Linked Functions	24
Loading/Unloading the instax mini Instant Film Pack	11	Direct print function	24
Loading the Film Pack.....	11	Remote shooting function	24
Unloading a Used Film Pack	12	Print image storage function.....	24
Basic Shooting and Playback	12	Specifications	24
Taking Photos.....	12	Troubleshooting	25
Playing Back the Images You Have Taken	13	IMPORTANT SAFETY NOTICE.....	26
Changing the Display on the Playback Screen	13	Simple Camera Care	27
Print.....	14	Bluetooth® Devices: Cautions.....	28
About the Remaining Film Sheets Display	15		
Adding Effects to Your Photos	15		
Selecting Lens Effects	15		
Selecting a Film Effect.....	16		
Specifying an Effect Combination.....	16		
Registering an Effect Combination	16		
Calling up Favorite Effects.....	16		

Before Use

Before using the camera, check you have the following.

Supplied Accessories

- Shoulder strap (1)

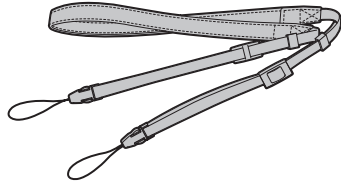

- Dedicated charging cable (1)

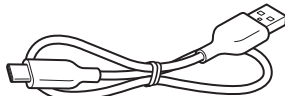

(BO38A34001)

- User's Guide (1)

- Use the strap over your shoulder, not around your neck.
- Make sure the shoulder strap does not hang over the film ejection slot.
- The battery has not been fully charged at the factory, be sure to charge the battery before using the camera.

Notes on Disposing of the Camera

A built-in lithium ion battery is used in this camera.

When you dispose of the camera, follow your local regulations and dispose of it properly.

Please refer to the supplied CONTACT INFORMATION sheet for disposal advice.

If your country or region is not included in the sheet, please contact your local distributor.

CAUTION

Do not remove the built-in battery by yourself; this may cause you injury.



Disposal of Electrical and Electronic Equipment in Private Households
 Disposal of used Electrical & Electronic Equipment (Applicable in the European Union and other European countries with separate collection systems)

This symbol on the product, or in the manual and in the warranty, and/or on its packaging indicates that this product should not be treated as household waste. Instead it should be taken to an appropriate collection point for the recycling of electrical and electronic equipment.

By ensuring this product is disposed of correctly, you will help prevent potential negative consequences to the environment and human health, which could otherwise be caused by inappropriate waste handling of this product.

The recycling of materials will help to conserve natural resources. For more detailed information about recycling of this product, please contact your local city office, your household waste disposal service or the shop where you purchased the product.

In Countries outside of EU: If you wish to discard this product, please contact your local authorities and ask for the correct method of disposal.



This Symbol on the batteries or accumulators indicates that those batteries should not be treated as household waste.

For customers in Turkey:

EEE Complies with Directive.

About This Camera

Main Features

- The highest image quality in the history of instax. (*As of December 2021)
- 100 different image expressions with 10 lens effects and 10 film effects.
- You can take photos while looking at the LCD Screen and save them to either the main unit or the micro SD card.
- You can choose which photos to print.
- Luxury classic design.
- Analog-like operation with lens dial, film dial, and print lever.
- Features a selfie mirror for easy selfies.

Functions Available with the Smartphone Application

- **Direct Print**
 Transfer a photo from your smartphone to the camera, and print it with the instax Direct Print feature. Before printing the photo, you can use the smartphone app to move, rotate, zoom in, zoom out, or crop the photo.
- **Remote Shooting**
 Control the camera with your smartphone for remote shooting of photos.
- **Print Photo Save**
 You can save printed photos taken with the camera to the smartphone app. You can add instax frames to your photos and save them on your smartphone.

Part Names

Front

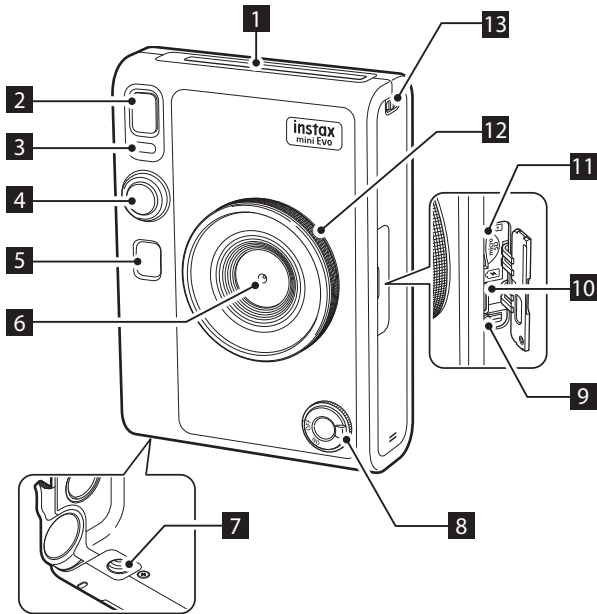

Rear

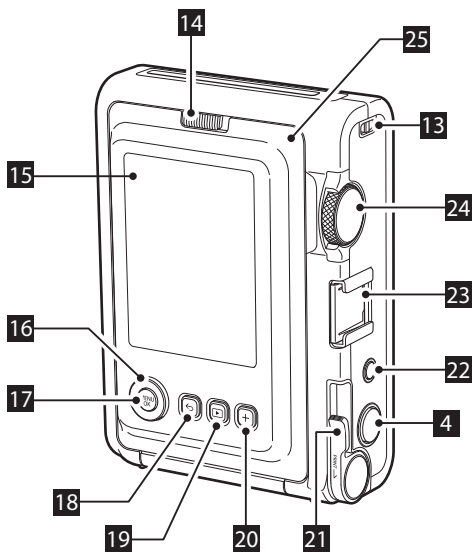

1 Film ejection slot

The exposed film is ejected from the film ejection slot during printing.

2 Flash

The flash operates depending on the setting. You can also set the flash to not operate.

3 Self timer lamp/Charging lamp

The self timer lamp/charging lamp blinks when you take a photo with the self-timer. It also lights up during charging and turns off when charging is complete.

4 Shutter button

Press the shutter button halfway to focus on the subject. Keeping the shutter button pressed halfway, press it fully to operate the camera shutter and take a photo. Press the shutter button in playback mode to switch to shooting mode.

5 Selfie mirror

You can see yourself in the selfie mirror to check the composition of the photo, and ensure you are in the shot.

6 Lens

This is the lens used to take photos. Make sure that your fingers or other body parts do not obstruct the lens during shooting.

7 Tripod hole

You can attach a tripod by using this hole.

8 Power switch

Turn the power switch clockwise to turn on the power. Turn it counter-clockwise to turn off the power.

9 Reset button *1

If the camera is not operating properly, press this button to force the camera to turn off. After pressing the reset button, turn the power switch off and then on again to start the camera. Do not use the reset button while the camera is operating normally. Doing so may cause the photo data to be erased.

10 USB Type-C port

This is the USB port for charging the camera. The USB port cannot be used for data transfer.

11 Micro SD card slot

This is the slot for a micro SD card.

12 Lens dial *2

Turn the lens dial to switch between 10 different lens effects.

13 Strap hook

Pass the cord on the strap through the strap hook to attach the strap to the camera.

14 Film door lock

Slide the film door lock to unlock the film door so that it can be lifted open.

*1 If the camera is not working properly, press the reset button to reset it.

*2 Lens effects are processed digitally.

15 LCD Screen

You can see the subject to be photographed during shooting and check photos you have taken on the LCD Screen. You can also view and select the menus on the LCD Screen.

16 Select buttons (◀▶⏪⏩)

Use the select buttons to select menu items and to use the functions displayed on the LCD Screen.

17 MENU/OK button

During shooting or playback, press the MENU/OK button to display the menu on the LCD Screen. This button is also used to confirm menu items.

18 ↶ (Back) button

Press the ↶ (Back) button to return to the previous screen. This button is also used to cancel photo printing.

19 ▶ (Playback) button

Press the ▶ (Playback) button to display the photos you have taken on the LCD Screen. When in shooting mode, this button is also used to switch to playback mode.

20 +(Function) button

Press the +(Function) button in shooting mode to check the current effect on the LCD Screen. You can also save and recall effects.

21 Print lever

Print the image displayed on the LCD Screen.

22 Effect reset button

Return both the lens and film effects to normal.

23 Accessory shoe

Attach camera accessories using the accessory shoe.

24 Film dial *3

Turn the film dial to switch between 10 different film effects.

25 Film door



When loading/unloading a film pack, slide the film door lock to unlock the film door and lift it open. Do not open the film door until you have used up the film.

*3 Film effects are processed digitally.

LCD Screen display

When the camera is turned on, the shooting screen appears on the LCD Screen.

- To switch from the shooting screen to the playback screen, press the  (Playback) button.
- To switch from the playback screen to the shooting screen, press the Shutter button fully.

If you press  (Back) while the shooting screen or playback screen is displayed, the following information will appear on the LCD Screen. To return to the shooting screen or playback screen, press  (Back) again.

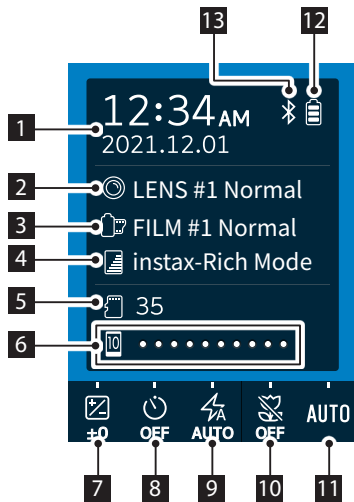

Shooting screen



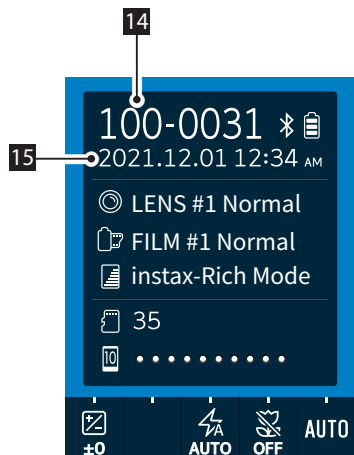

Playback screen







- 1 Current date and time
- 2 Lens effects
- 3 Film effects
- 4 Print quality
- 5 Number of shots available*4
- 6 Film remaining indicator
- 7 EXPOSURE
- 8 SELF-TIMER
- 9 FLASH
- 10 MACRO
- 11 WHITE BALANCE
- 12 Battery remaining indicator
- 13 Bluetooth connection status indicator
- 14 Frame number
- 15 Shooting date and time

*4  (Camera) is displayed when the internal memory is used. When the number of shots available is 10 or less, the icon is displayed in red.  (Memory card) is displayed when a memory card is used.

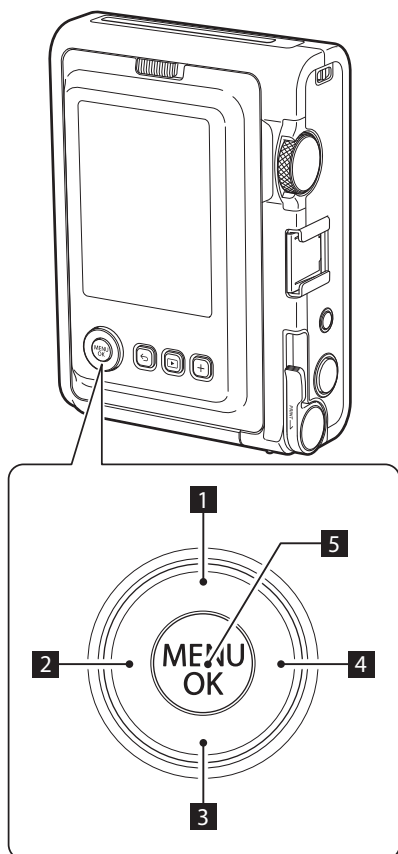
Using the Select buttons

The  (Up/Down/Left/Right) buttons are used to select menu items and to call the functions assigned to the  buttons. The [MENU/OK] button is used to display menus and make selections.



- 1  Move (up).
- 2  Move (left).
- 3  Move (down).
- 4  Move (right).
- 5 Determines which menu item is displayed or selected.

Attaching the Shoulder Strap

Follow the steps below to attach the shoulder strap to the camera body.

- 1 Insert one end of the shoulder strap through the strap hook on the camera.

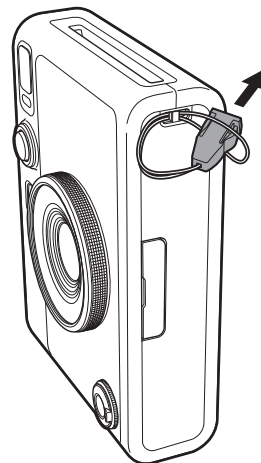

- 2 Attach the strap body to the end of the strap.

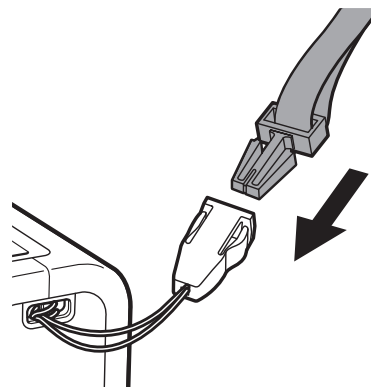

- 3 Attach the other end in the same manner.

- The shoulder strap should be worn on the shoulder, not hanging around the neck.
- Make sure the shoulder strap does not hang over the film ejection slot.

Charging the Battery

❗ Turn off the camera before charging the battery. Battery will not charge if the camera is turned on.

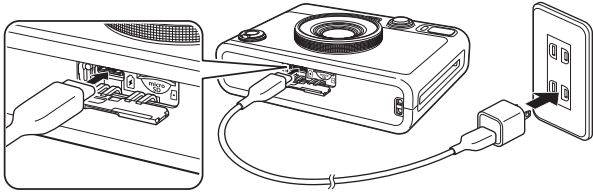

Connect the camera using the supplied dedicated charging cable to a USB AC adapter (supplied with your smartphone) then connect the USB AC adapter to an indoor power outlet.

- Charging time is approximately 2 to 3 hours.
- The power delivered by the charger must be between min 0.4 Watts required by the radio equipment, and max 2.5 Watts in order to achieve the maximum charging speed.

Charging Status Indication

While charging	Self timer lamp lights up.
Charging finished	Self timer lamp goes off.
Charging error	Self timer lamp flashes.

When charging from a PC:

- Connect the camera directly to the PC, not through a USB hub or keyboard.
- If the PC goes into hibernation (sleep mode) while charging, charging will be stopped. To continue charging, wake up the PC from hibernation (sleep mode) and reconnect the supplied dedicated charging cable.
- Depending on your PC's specifications, settings, or condition, it may not be possible to charge the battery.

- It is not possible to remove the battery.
- The battery has not been fully charged at the factory, be sure to charge the battery before using the camera.
- Please refer to "Simple Camera Care" for precautions regarding the battery. (p. 27)

Power On/Off

To turn the camera on, turn the power switch clockwise.

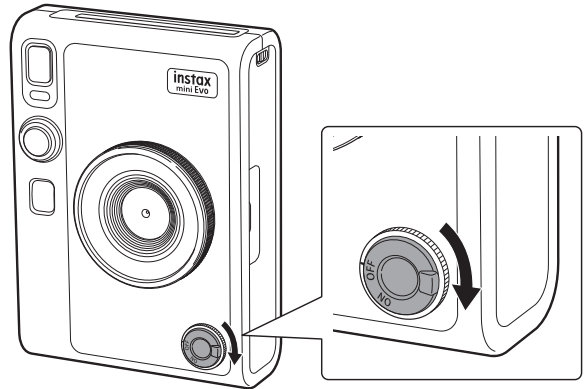



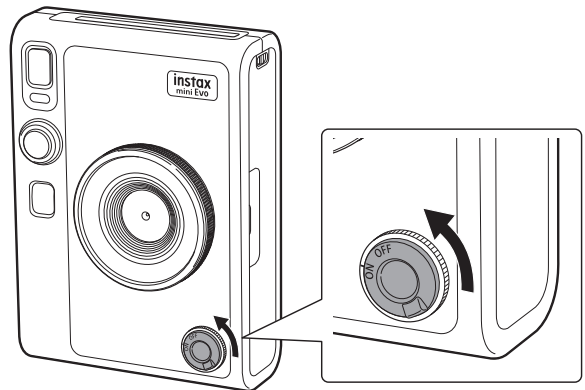

To turn the camera off, turn the power switch anticlockwise.





- If you do not operate the camera for a certain period of time, it will automatically turn off. If the camera turns off automatically, turn the power switch off and then on again to turn it on.
- You can also adjust the time until the camera turns off. (p. 22)

How to Check the Battery Level

Press  (Back) on the shooting or playback screen to display the remaining battery charge on the LCD Screen.

Display	Remaining battery charge
	Sufficient battery charge remaining.
	Less than half of battery charge remaining. Recharging the battery is recommended.
	Low battery charge. Please recharge the battery as soon as possible.

- When the battery charge is low, an icon () will also appear in the lower right corner of the LCD Screen.
- When the battery is completely depleted, an icon () will appear in the middle of the LCD Screen and the power will turn off.

To return to the shooting screen or playback screen, press  (Back) again.

Configure the initial settings

When you turn on the camera for the first time after purchase, you will be automatically prompted to set the language to use, the date and time, and to pair your smartphone.

Before pairing registration, install the “instax mini Evo” app on your smartphone.

- If you are using an Android OS smartphone, search for “instax mini Evo” on Google Play and install it.
*Requirements for Android OS smartphones: Android version 7 or later and have Google Play installed.
- If you are using an iOS smartphone, search for “instax mini Evo” in the App Store and install it.
*Requirements for iOS smartphones: iOS version 12 or later
Depending on your smartphone model, you may not be able to use the smartphone app even if you have installed it and meet the above operation requirements.

This setting can be set at a later time. If you want to set or re-set it later, set it from [言語/LANG.], [DATE/TIME], and [BLUETOOTH SETTINGS] in the setup menu.

1 Turning on the power.

- When you turn on the camera for the first time after purchase, the language setting screen will appear.

2 Select the language you want to use, and then press [MENU/OK].

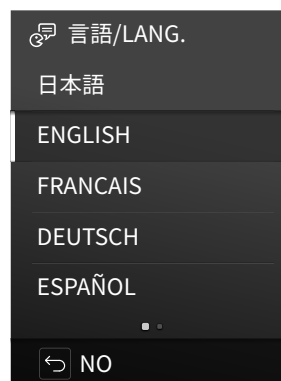

- 3** Set the year, month, and date in that order, and then press [MENU/OK].

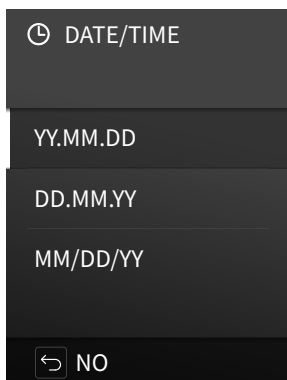

- 4** Set the year, month, day, hour, and minute, and then press [MENU/OK].

Press ◀ ▶ to select the item to be set (year, month, day, hour, minute) and then press ▲ and ▼ to select the number to be set.

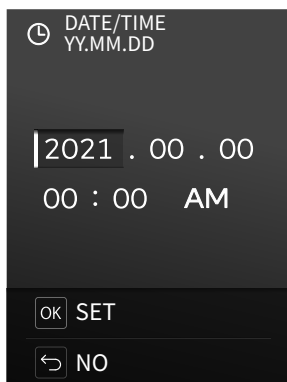

Next, configure the pairing settings.

- 5** Press [MENU/OK].

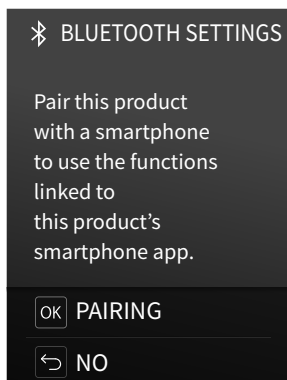

- If you do not want to configure the pairing settings, press ⏪ (Back) to exit the initial settings.

- 6** Launch the “instax mini Evo” smartphone app and tap [SETTINGS].

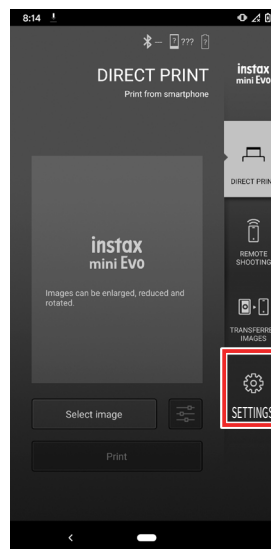

- 7** Tap [Bluetooth settings] on the smartphone app.

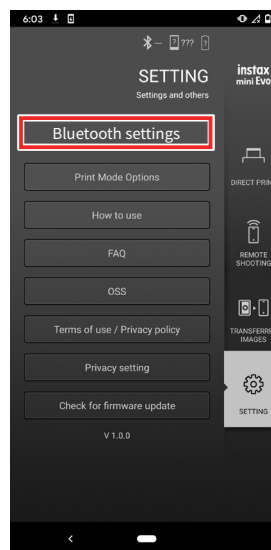

8 Tap [Connect] on the smartphone app.

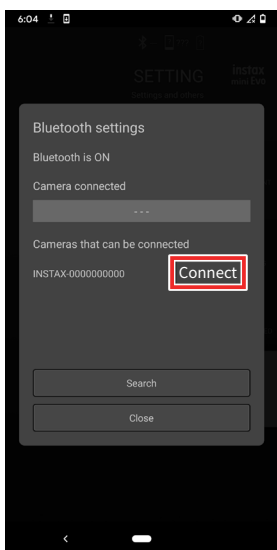

• To check the camera's OWN NAME, display the shooting menu. (p. 22) Then, select [BLUETOOTH SETTINGS], [INFORMATION], and [OWN NAME] in this order.

9 Allow pairing.

10 Confirm that pairing registration has been completed.

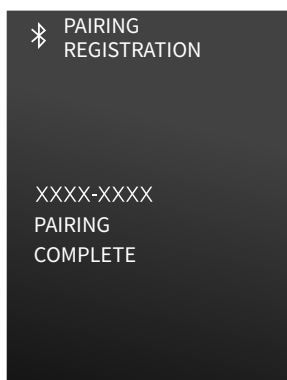

When pairing registration is complete, the screen switches to the shooting screen.

Loading/Unloading the instax mini Instant Film Pack

Loading the Film Pack

1 Slide the film door lock and open the film door.

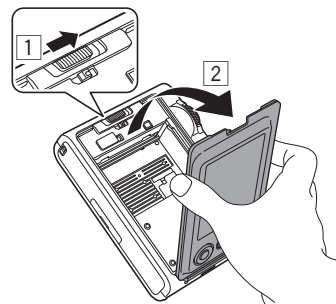

2 Insert film pack by aligning the yellow marks.

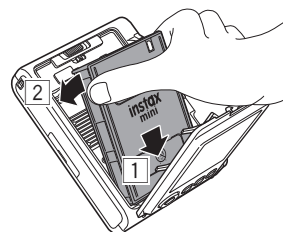

3 Close the film door.

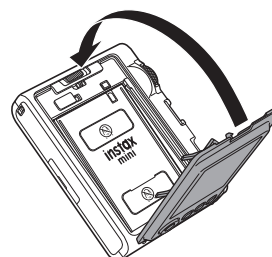

4 Remove the black film cover that is automatically rejected.

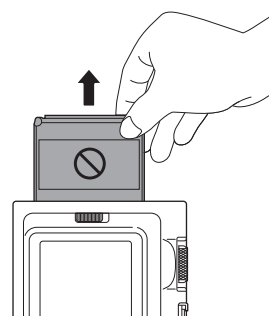

Unloading a Used Film Pack

- 1 Slide the film door lock and open the film door.

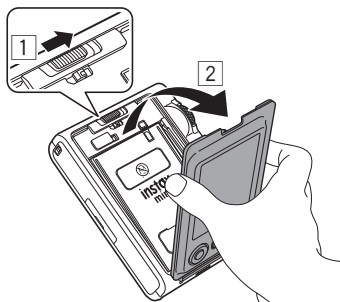

- 2 Grasp the rectangular holes on the film pack, then pull film pack out from the camera.

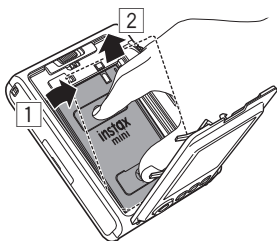

Basic Shooting and Playback

Taking Photos

This section explains the basic procedures to take photos.

- 1 Turn on the power.
- 2 Hold the camera.
- 3 Set effects and other settings as desired.
- 4 Compose the photo.
Press or to adjust the composition. Press to take a larger image of a distant subject, or press to take a larger area.
- 5 Press the Shutter button halfway to bring the subject into focus.

When the subject is in focus

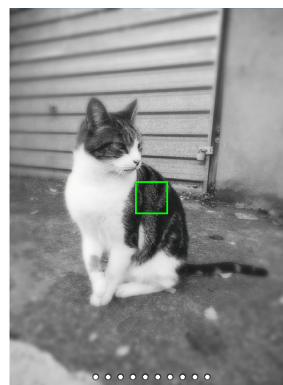

A beep is heard and a green AF frame appears on the LCD Screen.

When [FACE DETECTION] is enabled, a green AF frame appears over the face of the person when the camera recognizes their face. (p. 22)

When the subject is not in focus

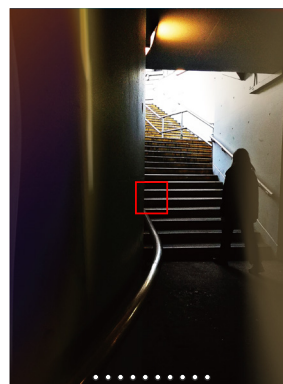

A red AF frame appears on the LCD Screen. Change the composition or use AF/AE lock. (p. 20)

6 Hold the Shutter button halfway down and press it in (all the way down)

After taking a photo, the image is stored in the internal memory or on the memory card.

- See "Print" for the procedure to print photos you have taken. (p. 14)



- When taking a photo, hold your arms tightly against your body and hold the camera firmly with both hands.
- Be careful not to touch the camera lens when you press the Shutter button.
- When fully pressing the Shutter button, press it gently to prevent the camera from moving and causing the photo to blur.
- Be careful not to let your fingers or the shoulder strap cover the flash or lens.
- In dark or backlit conditions, the flash may fire when the Shutter button is pressed fully. You can change the flash settings to prevent the flash from firing. (p. 18)

Precautions regarding the internal memory

- If the internal memory is full, the shutter will not release and you will not be able to take photos. Delete images or use a memory card.
- If the camera malfunctions, images in the internal memory may be damaged or lost.
- We recommend that you copy important images to another media (hard disk, CD-R, CD-RW, DVD-R, etc.) for backup.
- If you send the camera in for repair, we cannot guarantee the data in the internal memory.
- When the camera is repaired, we may need to check the data in the internal memory.

Playing Back the Images You Have Taken





You can play back the images you have taken on the LCD Screen.

- 1 Turn on the power.
- 2 Press  (Playback).
The last photo you took is displayed.
- 3 Press  or  to select the image you want to view.
 - Press the Shutter button fully to return to the shooting screen.

Changing the Display on the Playback Screen

You can zoom in on an image or change the number of frames displayed on the LCD Screen.





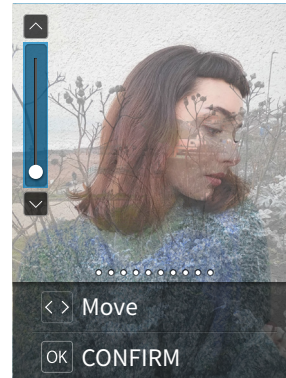

■ To Zoom In on an Image

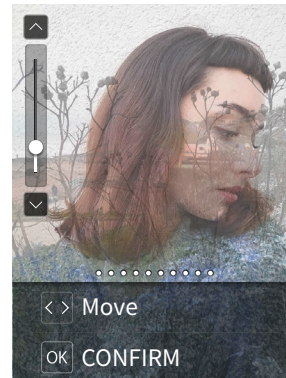
- 1 Press  or  to select the image you want to view.
- 2 Press  or .
The zoom in/out screen appears.



- 3 Press  or  to zoom in or out on the image.



- When you press  or  on the zoom in/out screen, the screen switches to the move screen, and you can press    to move the screen position. To return to the zoom in/out screen, press .



- 4 Press [MENU/OK].
 - You can also print a zoomed-in or zoomed-out image.

■ Changing the Number of Frames Displayed

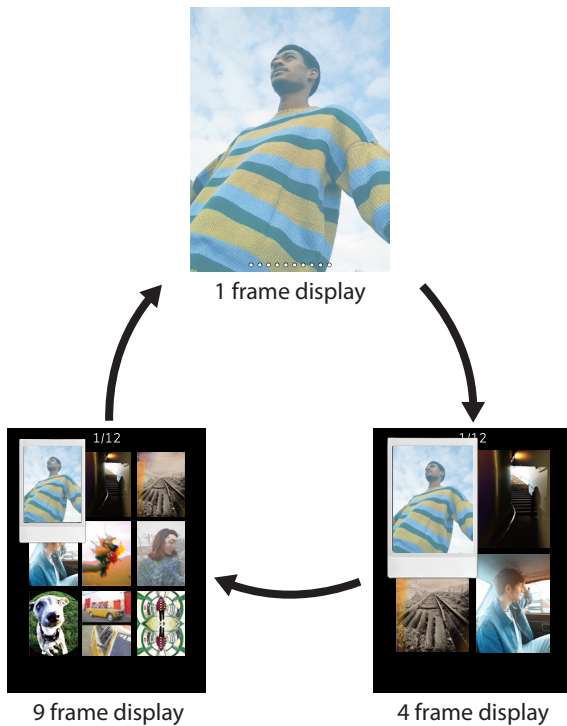
When the playback screen is displayed, press  (Playback) to change the number of frames displayed.



Print

- 1 Press the  (Playback) button.
- 2 Press  or  on the Select button to select the photo you want to print.
- 3 You have the option to enlarge the photo, or make other edits.
- 4 Turn the print lever to print.

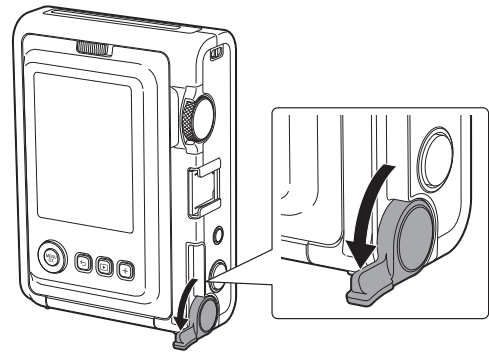

- 5 After the sound of the film ejecting stops, hold the tip of the ejected film and remove it.

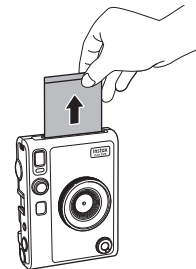

Be careful not to let your fingers or the camera strap get caught in the film ejection slot.

About the Remaining Film Sheets Display

The number of remaining film sheets is indicated by a white dot at the bottom of the screen. Each time you finish a print, this dot turns gray. When there are only two film sheets remaining, the dot turns red.



10 sheets remaining display

2 sheets remaining display

0 sheets remaining display

- For details on the handling of film, see the instructions of FUJIFILM Instant Film instax mini.
- Film develops in about 90 seconds (the time varies with temperature).

Adding Effects to Your Photos

Selecting Lens Effects

Follow the steps below to select the type of lens effect to apply.

- 1 Display the shooting screen.
- 2 Rotate the Lens dial to select the type of lens effect.

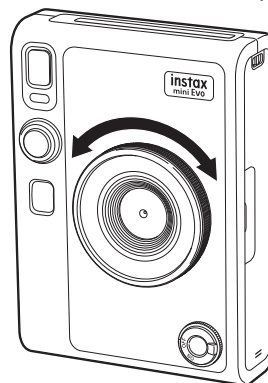

The following guide appears.

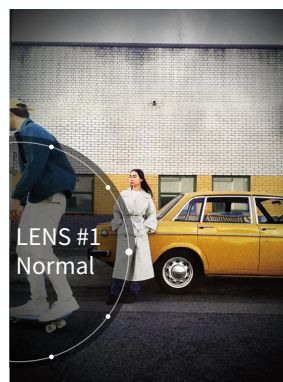

- To cancel the set lens effect, select [Normal] from the lens effect types.
- Press the Effect reset button to cancel the set lens effect and film effect.

You can also press the + (Function) button to recall your favorite registered lens effects and film effects.

Selecting a Film Effect

Follow the steps below to select the type of film effect.

- 1 Display the shooting screen.
- 2 Turn the film dial to select the type of film effect.

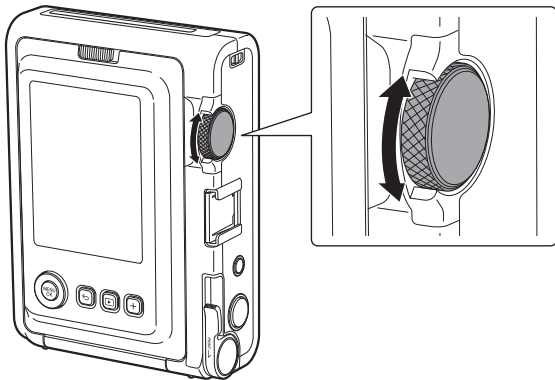

The following guide appears.

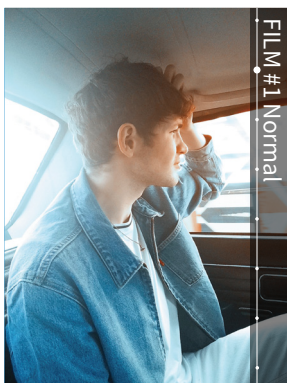

- To cancel the set film effect, select [Normal] from the film effect types.
- Press the Effect reset button to cancel the set lens effect and film effect.

You can also press the + (Function) button to recall your favorite registered lens effects and film effects.

Specifying an Effect Combination

You can register a combination of your favorite effects. You can recall a registered effect combination by pressing the + (Function) button.

Registering an Effect Combination

- 1 Display the shooting screen.
- 2 Rotate the Lens dial to select the type of lens effect.
- 3 Turn the film dial to select the type of film effect.
- 4 Press the + (Function) button.
- 5 Press [MENU/OK].
- 6 Press ◀ or ▶ to select [Favorite[1]] to [Favorite[3]].
Up to three effect combinations can be registered.
- 7 Press [MENU/OK].
The effect is registered.

Calling up Favorite Effects

- 1 Display the shooting screen.
- 2 Press the + (Function) button twice.
- 3 Press ◀ or ▶ to select [Favorite[1]] to [Favorite[3]].
- 4 Press [MENU/OK].
The effect is applied.

Various Shots

Changing the Brightness of the Image

Adjust the brightness of the image. Use this function when the subject is too bright or too dark, or when the contrast (difference between light and dark) between the subject and the background is too great.

- 1 Press or until [EXPOSURE] appears on the shooting screen.



- 2 Press or to correct the exposure.
 - Press to correct the exposure to the + side to brighten the entire image.
 - Press to adjust the exposure to the - side to darken the entire image.
- 3 Press the Shutter button all the way down.

Using the Self-Timer to Take Photos

Use this function to take a group photo including the photographer or to prevent the camera from moving while the Shutter button is pressed.

- 1 Press or until [SELF-TIMER] appears on the shooting screen.

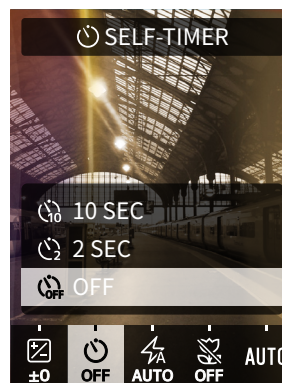

- 2 Press or to select [2 SEC] or [10 SEC].
The icon corresponding to the set self-timer appears in the center of the screen.
• If you do not want to set a self-timer, select [OFF].
- 3 Press the Shutter button all the way down.
The countdown starts.
When [2 SEC] is selected:
When you press the Shutter button, the self-timer light flashes.
When [10 SEC] is selected:
When you press the Shutter button, the self-timer light lights up and starts flashing three seconds before taking the photo.

To cancel the self-timer halfway through, press (Back).

Taking Photos with the Flash

Use the flash when taking photos at night or in a dark room. You can also set the camera so that the flash does not fire.

- 1 Press or until [FLASH] appears on the shooting screen.

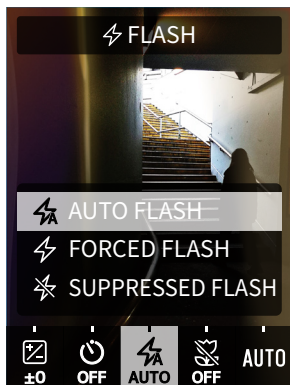

- 2 Press or to select the flash setting.
 - For more information on flash settings, see “Types of Flash”.

- 3 Press the Shutter button all the way down.

• If you press the Shutter button while the flash is charging, the self-timer light will flash and the shutter will not release.

■ Types of Flash

AUTO FLASH

The flash will fire automatically when the surroundings are dark. This setting applies to most situations.

FORCED FLASH

The flash will fire regardless of the brightness of the surroundings. Use this setting when the subject is dark due to backlighting.

SUPPRESSED FLASH

The flash will not fire even if the surroundings are dark. This setting is suitable for shooting in places where flash photography is prohibited.

When shooting in dark places without using the flash, it is recommended to steady the camera on a table or similar surface.

Taking Macro Photos

Use macro shooting when you want to get close to the subject.

- 1 Press or until [MACRO] appears on the shooting screen.

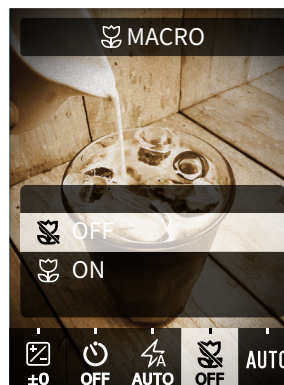

- 2 Press or and select [ON].
- 3 Press the Shutter button all the way down. Macro shooting is performed.

Matching the Light Source when Taking Photos

By setting the white balance to match the light source, such as sunlight or artificial lighting, you can shoot with colors closer to real life.

- 1 Press or until [WHITE BALANCE] appears on the shooting screen.



- 2 Press or to select one of the settings.
 - For details on setting the white balance, see "Types of White Balance".
- 3 Press the Shutter button all the way down.

Types of White Balance

- AUTO**
The camera sets the white balance automatically. AUTO is recommended for normal shooting.
- FINE**
For outdoor shooting in fine weather.
- SHADE**
For shooting on cloudy days or in the shade.
- FLUORESCENT LIGHT-1**
For shooting under daylight fluorescent lighting.
- FLUORESCENT LIGHT-2**
For shooting under daylight white fluorescent lighting.
- FLUORESCENT LIGHT-3**
For shooting under white fluorescent lighting.
- INCANDESCENT**
For shooting under light bulbs and incandescent lamps.

Taking a Photo of Yourself (Selfie)

You can use the selfie mirror to take photos of yourself.

- 1 Hold the camera securely so that your face comes 30 to 50 cm away from the end of the lens.
 - Hold the camera securely, as camera shake is especially likely to occur in the dark.

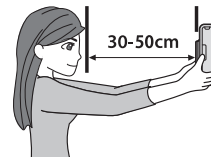

- 2 Confirm the composition using the selfie mirror, then take a photo.

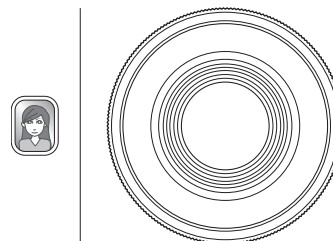

- Do not stare at the flash when taking photos. Flash afterimages may cause temporary blindness.

Using AF/AE Lock to Take Photos

When taking a photo, pressing and holding the Shutter button halfway to lock the focus is called "AF lock," and pressing and holding the Shutter button to lock the brightness is called "AE lock." This is useful when you want to take a photo where the subject is not in the center of the screen.





- 1 Press the Shutter button halfway to bring the subject into focus.**
Press the Shutter button halfway to lock AF or AE.
- 2 Press and hold the Shutter button halfway to change the composition.**
- 3 Press the Shutter button fully to take the photo.**

It is recommended that you use AE/AF lock when taking photos of the following objects, as they may be difficult to focus on.

- Shiny objects, such as mirrors and car bodies
- Subjects that are moving at high speed
- Subjects on the other side of glass
- Dark objects, such as hair or fur, that absorb light rather than reflect it
- Insubstantial objects such as smoke or flames
- Subjects with little difference between light and dark (for example, a person wearing clothes the same color as the background)
- When there is a large contrast difference in the AF frame and the subject is in that area (for example, a subject in front of a high-contrast background)

Printing from Print History

You can recall images that you printed previously and retain the settings (image effects, etc.) used at that time. You can print the images you have taken by following the steps below.

- 1 On the playback screen, press [MENU/OK].**
The playback menu appears.
- 2 Press  or  to select [PRINT HISTORY].**
- 3 Press [MENU/OK].**
- 4 Press  or  to select the image you want to print.**

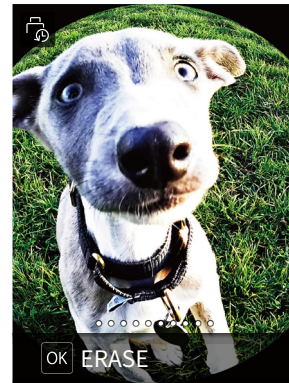

- 5 Turn the Print lever.**
Printing starts.

To cancel printing halfway through, press  (Back).

- 6 When the sound of the film being ejected stops, grasp the edge of the ejected film and take the film out.**

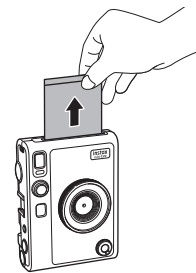

Be careful not to let your fingers or the shoulder strap cover the Film ejection slot.

Using the Memory Card

The camera's internal memory can store about 45 still images, but you can store more images by using a memory card. You will also need a memory card to upgrade the firmware. Please prepare a memory card in advance.

Precautions Regarding Memory Cards

- This camera is compatible with micro SD cards and micro SDHC cards. Using other types of memory cards may cause damage to the camera.
- Memory cards are small and may be accidentally swallowed by infants. Keep them out of the reach of infants. In the unlikely event that an infant swallows a memory card, consult a physician immediately.
- **Do not turn off the camera or remove the memory card during formatting or while recording/deleting data. The memory card may be damaged.**
- Do not use or store memory cards in an environment that is prone to strong static electricity or electrical noise.
- Inserting a memory card charged with static electricity into the camera may cause the camera to malfunction. If this happens, turn the camera off and then on again.
- Do not carry a memory card in the pocket of your pants. A strong force may be applied when you sit down, which may cause the memory card to break.
- The memory card may become hot to the touch after prolonged use, but this is not a fault.
- Do not put any labels on memory cards. If the label comes off, it may cause the camera to malfunction.

Precautions Regarding Using a Memory Card on a PC

- Always format an unused memory card or a memory card that has been used on a PC or other device before using it in the camera.
- When a memory card is formatted in the camera and used for shooting and recording, folders are automatically created. Do not use your PC to rename or delete folders or files on the memory card. Doing so may make the memory card in the camera unusable.
- Do not use your PC to delete images on the memory card. Always use the camera.
- If you want to edit an image file, copy or move the image file to a hard disk or similar device, and then edit the copied or moved image file.

Inserting a Memory Card

1 Open the card slot cover.

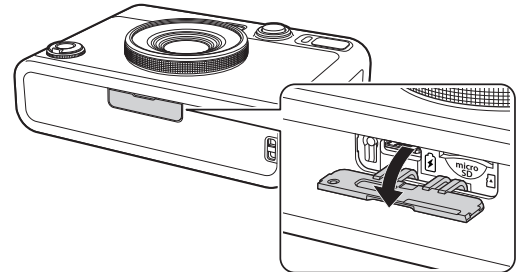

2 Insert the memory card all the way in the correct orientation as shown until you hear a "click".

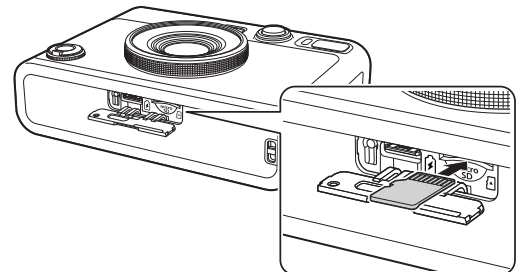

3 Close the card slot cover.

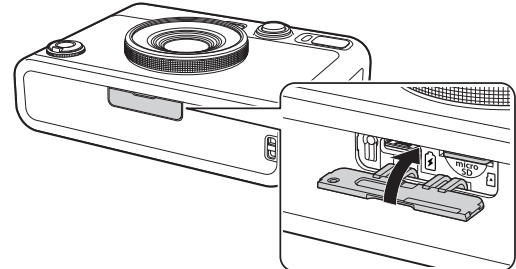

- To remove the memory card, push the card in with your finger and then release your finger gently. The card will be unlocked and ready to be removed.



If you suddenly release your finger while removing the memory card, the card may pop out. Release your finger gently.

Using the Shooting Menu

You can use the shooting menu to change various settings related to shooting.

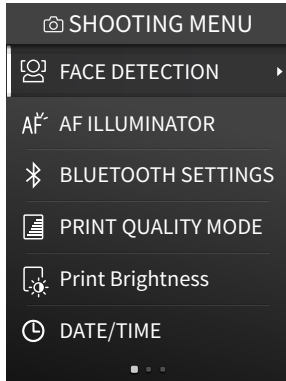
- 1 On the shooting screen, press [MENU/OK].
The shooting menu appears.



- 2 Press  or  to select an item.
• For details on each item, see “Shooting Menu Items”.
- 3 Changing the Settings.
- 4 Press [MENU/OK].
The setting is applied and the display returns to the shooting screen.

■ Shooting Menu Items

[FACE DETECTION]

When [FACE DETECTION] is turned on, the camera detects the person's face and adjusts the focus and brightness to the face instead of the background to make the person stand out brightly.

[AF ILLUMINATOR]

When set to ON, the AF ILLUMINATOR lights from the time the Shutter button is pressed halfway until the subject is in focus, making it easier to focus on a dark subject.

- Depending on the scene, it may be difficult to get the subject in focus even when the AF ILLUMINATOR is activated.
- The AF ILLUMINATOR may not be fully effective when shooting close to the subject.
- Do not flash the AF ILLUMINATOR close to the human eye.

[BLUETOOTH SETTINGS]

Install the smartphone app on your smartphone before pairing the camera.

[PAIRING REGISTRATION]:

When connecting the camera to your smartphone via Bluetooth for the first time, you will need to pair the devices together. Please refer to the following procedure for pairing.

1. Select [BLUETOOTH SETTINGS] from the SHOOTING MENU or the PLAYBACK MENU.
2. Select [PAIRING REGISTRATION] and press [MENU/OK]

3. Press [SETTINGS] on the smartphone app
4. Press [Bluetooth settings] on the smartphone app
5. Press [Connect] on the smartphone app
6. Allow pairing

[DELETE PAIRING REG.]:

You can delete the information of a paired smartphone.

[INFORMATION]:

Displays the Bluetooth address and name of the device and information about the paired device.

[PRINT QUALITY MODE]

Set to [instax-Natural Mode] for regular quality, or [instax-Rich Mode] for richer color representation (factory default).

[Print Brightness]

Set [×1 (standard)], [×1.5 (semi-bright)], or [×2.0 (bright)].

[DATE/TIME]

Sets the date and time.

[DATE STAMP]

Stamps the date on the image. If you want to erase the date stamped on the image, set to [OFF].

[言語/LANG.]

Sets the language displayed on the LCD Screen.

[SOUND SET-UP]

Sets the volume of the operation sound, shutter volume, and start-up sound.

If you want to turn off the sound, set this to [OFF].

[AUTO POWER OFF]

Sets the time to turn off automatically when the camera is not operated.

[RESET]

Resets the settings to the factory default values.

The date and time set in DATE/TIME will not be reset.

[FORMAT]

Initializes the camera's internal memory or a memory card inserted in the card slot. All stored images will be deleted.

[FIRMWARE UPGRADE]

Upgrades the firmware. There are two methods to upgrade the firmware, as shown below.

A memory card is required to upgrade the firmware. Please prepare a memory card in advance.

● Using the “instax mini Evo” Smartphone App

1. Insert the memory card into the card slot of the camera
2. Launch the “instax mini Evo” smartphone app
3. Tap [SETTINGS] in “instax mini Evo”
4. Click [Check for firmware update] in “instax mini Evo”
5. Follow the on-screen instructions

● Using the Camera

1. Download the latest firmware (FUPDATE.DAT) from the FUJIFILM website using a PC or other device, and copy it to the root directory of the memory card
2. Insert the memory card with the copied firmware into the camera card slot
3. Select [FIRMWARE UPGRADE] from the SHOOTING MENU or PLAYBACK MENU
4. Follow the on-screen instructions

Using the PLAYBACK MENU

You can use the PLAYBACK MENU to change various playback-related settings.

- 1 On the playback screen, press [MENU/OK].
The playback menu appears.

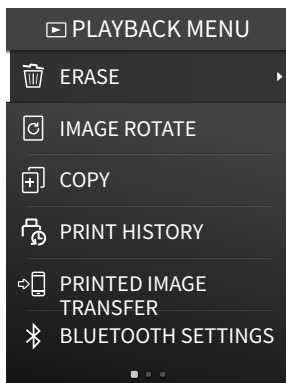

- 2 Press or to select an item.
For details on each item, see “Items in the PLAYBACK MENU”.
- 3 Changing the Settings.
- 4 Press [MENU/OK].
The settings are applied and the display returns to the previous screen.

■ Items in the PLAYBACK MENU

[ERASE]

Erases images one frame at a time or all frames at once.

[IMAGE ROTATE]

Rotates the image in 90-degree increments and displays it.

[COPY]

Copies images from the internal memory to the memory card or from the memory card to the internal memory.

Follow the steps below.

1. Select [COPY] from the PLAYBACK MENU
2. Select the copy destination and press [MENU/OK]
3. Select [FRAME] or [ALL FRAMES] and press [MENU/OK]
If you selected [ALL FRAMES], copying starts. If you selected [FRAME], go to step 4.
4. Press or to select the image you want to copy.
5. Press or and select [COPY]
6. Press [MENU/OK]

[PRINT HISTORY]

- Displays up to 50 images that have been printed previously.
- Select an image and turn the Print lever to start printing.
- Press [MENU/OK] to clear the print history frame by frame.

[PRINTED IMAGE TRANSFER]

You can send images printed with the camera to the smartphone app to save them as instax frame images on your smartphone.

For more information on the following items, please refer to the same items in “Using the Shooting Menu”. (p. 22)

[BLUETOOTH SETTINGS]/[PRINT QUALITY MODE]/[Print Brightness]/[DATE/TIME]/[DATE STAMP]/[言語/LANG.]/[SOUND SET-UP]/[AUTO POWER OFF]/[RESET]/[FORMAT]/[FIRMWARE UPGRADE]

Smartphone App Linked Functions

The following functions are available when connected with the “instax mini Evo” smartphone app.

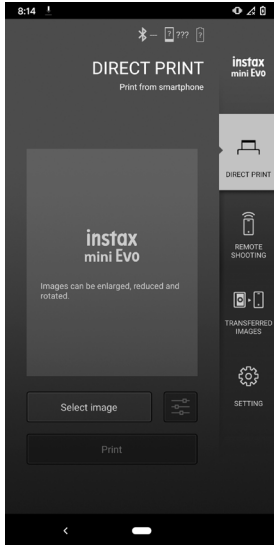

Direct print function

This function allows you to send images from your smartphone to the camera for instax printing. You can use the smartphone app to move, rotate, and zoom the image before sending it.

Remote shooting function

You can set the flash and self-timer with the smartphone app and take photos remotely.

Print image storage function

You can send images printed with the camera to the smartphone app to save them as instax frame images on your smartphone.

Specifications

■ Camera Function

Image sensor	1/5-inch CMOS with primary color filter
Number of recorded pixels	2560 × 1920
Storage media	Internal memory, microSD/microSDHC memory card
Storage capacity	Approximately 45 images in internal memory, approximately 850 images per 1 GB in microSD/microSDHC memory card
Recording method	DCF compliant Exif Ver 2.3
Focus distance	f = 28 mm (35 mm film equivalent)
Aperture	F2.0
Auto focus	Single AF (with AF Illuminator)
Shooting distance	10 cm to ∞
Shutter speed	1/4 second to 1/8000 second (automatic switching)
Shooting sensitivity	ISO100 to 1600 (automatic switching)
Exposure control	Program AE
Exposure compensation	-2.0 EV to +2.0 EV (1/3 EV step)
Metering method	TTL 256 split metering, multi metering
White balance	Auto, Fine, Shade, Fluorescent 1, Fluorescent 2, Fluorescent 3, Incandescent
Flash	AUTO FLASH/FORCED FLASH/SUPPRESSED FLASH Shooting range with flash: Approximately 50 cm to 1.5 m
Self-timer	Approximately 2 seconds / approximately 10 seconds
Image effects	10 lens effects, 10 film effects Total of 100 effects by multiplying above

■ Print function

Exposure pixel count	1600 × 600 dots (800 × 600 dots when printed from smartphone app)
Exposure resolution	25 dots/mm × 12.5 dots/mm (635 × 318 dpi, 40 × 80 μm dot pitch) 12.5 dots/mm when printed from smartphone app (318 dpi, 80 μm dot pitch)
Exposure gradation	RGB gradation of 256 colors
Interface	Standard compliance: Bluetooth Ver. 4.2 (BLE)

Printable image format	JPEG images taken with this unit
Print output time	Approximately 16 seconds * Plus 7 seconds when printed using instax-Rich Mode immediately after startup.
Print function	Images in the internal memory and images in the memory card can be printed
Reprint	Reprint is possible for images stored in print history (up to 50)

■ Other

Smartphone app linked functions	Smartphone image print function, remote shooting function, printed image transfer function, firmware upgrade function
LCD screen	3.0-inch TFT color LCD screen Pixel count: Approximately 460,000 dots
External interface	USB Type-C port (for charging only)
Power supply	Lithium ion battery (internal type: not removable)
Charging function	Built-in
Possible number of printed images	Approximately 100 (from full charge) *The number of prints depends on the usage conditions.
Charging time	Approximately 2 to 3 hours *Charging time depends on the temperature.
Main unit dimensions	87 mm × 122.9 mm × 36 mm (excluding projecting parts)
Main unit weight	Approximately 285 g
Operating environment	Temperature: 5°C to 40°C Humidity: 20% to 80% (no condensation)
Film used	FUJIFILM instant film "instax mini" (sold separately)

* The above specifications are subject to change for better performance.

Troubleshooting

Please check the following items before considering a problem to be a malfunction. If the problem persists even after taking action, please contact our service center for repair or visit the website below.

FUJIFILM website: <https://global.fujifilm.com/>

If the following problem occurs...

Problem	Possible causes and solutions
I cannot turn on the camera.	The battery may be exhausted. Please charge the camera.
The battery is exhausted quickly.	If you use the camera in a very cold environment, the battery will drain quickly. Please keep the camera warm before shooting.
Camera shuts down during use.	The battery level may be low. Please charge the camera.
Charging does not start.	<ul style="list-style-type: none"> • Make sure that the USB power adapter plug is properly connected to the power outlet. • Turn off the camera when charging it. If power is on camera will not charge.
It takes too long to charge.	At low temperatures, charging may take some time.
The self-timer lamp flashes while charging.	Charge the battery in a temperature range of +5 °C to +40 °C. If you cannot charge the battery within this range, please contact our support center.
I cannot shoot when I press the shutter button.	<ul style="list-style-type: none"> • Make sure that the power is on. • If the battery level is low, please charge the camera. • If the internal memory or memory card is full, insert a new memory card or delete unnecessary images. • Use a memory card formatted with this unit. • If the contact surface of the memory card (gold part) is dirty, wipe it with a soft, dry cloth. • The memory card may be broken. Please insert a new memory card.
I cannot focus the camera.	Use the AF/AE lock to shoot subjects that are difficult to focus on.
The flash does not fire.	Check that the suppressed flash setting has not been selected. Select a setting other than the suppressed flash setting.
Even though the flash fired, the image is dark.	<ul style="list-style-type: none"> • Check that you are not too far from the subject. Please shoot within the flash range. Approximately 50 cm to 1.5 m. • Hold the camera correctly so that you do not obstruct the flash with your fingers.

Problem	Possible causes and solutions
The image is blurred.	<ul style="list-style-type: none"> • If the lens has dirt on it such as fingerprints, clean the lens. • Make sure that the AF frame is green before taking a photo.
The camera does not work properly.	<ul style="list-style-type: none"> • There may be a temporary malfunction. Please press the reset button. If it still does not work properly, please contact our repair service center for repair. • The battery may be exhausted. Please charge the camera.
The film pack does not load or does not load smoothly.	<ul style="list-style-type: none"> • Please use FUJIFILM instant film "INSTAX mini" (other films cannot be used). • Align the yellow mark on the film pack with the yellow alignment mark on the camera body to load the film.
The film does not unload.	<ul style="list-style-type: none"> • The film may be misaligned due to shocks such as vibration or dropping. Please load a new film pack. • If the film is jammed, turn off the camera and turn it on again. If the problem persists, remove the jammed film and then load a new film pack.
Some or all of the finished prints are white.	Do not open the film door until all film exposures have been used. Unexposed film will be prematurely exposed if the door is opened. Prematurely exposed film will be white with no images.
The print is uneven.	<ul style="list-style-type: none"> • Do not shake, bend, fold or hold the print immediately after it is printed. • Do not obstruct the film ejection slot.

IMPORTANT SAFETY NOTICE

This product has been designed to ensure the safety of the user when handled correctly in accordance with the User's Guide and the instructions provided. It is important that both the product and the "instax mini" film are handled properly and used only to print pictures as instructed in the User's Guide and in the "instax mini" film instructions. For future reference keep the User's Guide in a safe, easy place.

WARNING

This symbol indicates danger, which could result in injury or death. Please follow these instructions.

WARNING

- ⚠ If any of the following instances occur, immediately unplug the dedicated charging cable, turn the camera off and cease use.
 - The camera becomes hot, emits smoke, emits a burnt smell or is functioning abnormally.
 - The camera is dropped into water or any foreign objects enter the camera.
- ⚠ This device contains a built-in battery. Do not subject it to heat, throw it into an open fire, drop or subject to impact. Doing so could cause the camera to explode.

WARNING

- ⚠ Never attempt to take this product apart. You may be injured.
- ⚠ If the camera is not functioning correctly, to avoid injury do not attempt to repair yourself.
- ⚠ If this product is dropped or damaged so that the internals are visible, do not touch it. Contact your FUJIFILM dealer.
- ⚠ Do not touch any parts within the inside of the back cover. This may cause injury.
- ⚠ Never get this product wet or handle it with wet hands. Doing so may result in an electric shock.
- ⚠ Promptly unplug the dedicated charging cable once battery is fully charged.
- ⚠ Keep out of the reach of small children. This product could cause injury in the hands of a child.
- ⚠ Do not cover or wrap the camera or the AC power adapter in a cloth or blanket. This can cause heat to build up and distort the casing or cause a fire.



The "CE" mark certifies that this product satisfies the requirements of the EU (European Union) regarding safety, public health, environment and consumer protection. ("CE" is the abbreviation of Conformité Européenne.)

Hereby, FUJIFILM declares that the radio equipment type "FI019" is in compliance with Directive 2014/53/EU.

For more information, access the website below.

https://instax.com/mini_evo/en/spec.html

UK
CA

The "UKCA" mark certifies that this product satisfies the requirements of Great Britain (England, Scotland, Wales) regarding safety, public health, environment and consumer protection.

*UKCA: UK Conformity Assessed.

Simple Camera Care

■ Handling the Camera and Battery

- CAUTION - Do not expose to excessive heat such as sunshine, fire or the like, that can result in an explosion or the leakage of flammable liquid or gas during use, storage or transportation or disposal.
- CAUTION - Do not dispose of a battery into fire or a hot oven, or mechanically crush or cut the battery, as this may result in an explosion.
- CAUTION - Do not subject to extremely low air pressure at high altitude that may result in an explosion or the leakage of flammable liquid or gas.

■ Camera Care

1. Do not open the film door until all film exposures have been used, doing so will prematurely expose the remaining film and render it unusable.
2. Your camera is a fragile object. Do not expose it to water, sand or gritty materials.
3. Do not use a strap made for cellular phones or other similar electronic products. These straps are usually too weak to hold your camera securely. For safety, only use straps designed for your camera, and use only as specifically intended and instructed.
4. Do not use solvent such as thinner or alcohol to remove dirt.
5. Do not leave your camera in direct sunlight or hot places such as the inside of a car. Do not leave the camera in damp places for prolonged periods.
6. Moth repellent gas such as naphthalene may affect your camera and prints. Take care to keep your camera and prints in a safe, dry place.
7. Note that the temperature range within which your camera can be used is +5°C to +40°C.
8. Take great care to ensure that printed materials do not violate copyright, image rights, privacy or other personal rights and do not offend public decency. Actions that violate the rights of others, are contrary to public decency or constitute a nuisance may be punishable by law or otherwise legally actionable.

■ Handling the LCD Screen

As the LCD Screen can be easily scratched or damaged by sharp or solid objects, we recommend you attach a protective sheet (commercially available) onto the LCD Screen.

■ Charging the Battery

The battery has not been charged during manufacture. Please charge the battery fully before first use.

Charge the battery using the supplied dedicated charging cable. Charging times will increase at ambient temperatures below +10°C or above +35°C. Do not attempt to charge the battery at temperatures above +40°C or at temperatures below +5°C as the battery will not charge.

■ Battery Life

At normal temperatures, the battery can be recharged about 300 times. A noticeable decrease in the length of time the

battery will hold a charge indicates that it has reached the end of its service life.

■ Caution: Handling the Battery

The battery and camera body may become warm to the touch after extended use. This is normal.

■ Certification marks are located inside the film chamber.

■ Cautions During Printing

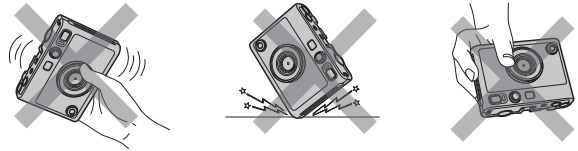

■ "instax mini" Film and Print Care

See FUJIFILM Instant Film "instax mini" packaging for film use instructions. Follow all instructions for safe and proper use.

1. Keep the film in a cool place. Do not leave the film in a place where the temperature is extremely high (e.g., in a closed car) for many hours.
2. Do not puncture, tear, or cut the film. If film becomes damaged, do not use.
3. When you load a film pack, use the film as soon as possible.
4. If the film has been kept in a place where the temperature is extremely high or low, bring it to room temperature before starting to print pictures.
5. Be sure to use the film before the expiration or "Use Before" date.
6. Avoid airport checked luggage scanning and other strong X-ray exposure. The effect of fogging, etc. may appear on unused film. We recommend that you carry the camera and/or the film onto the aircraft as carry-on luggage. (Check with each airport for more information.)
7. Avoid strong light, and keep the developed prints in a cool and dry place.
8. Do not puncture or cut the film as it contains a small amount of caustic paste (high alkaline). Never let children or animals put the film into their mouth. Also ensure that the paste does not come into contact with skin or clothes.
9. Should the paste inside the film comes into contact with skin or clothes, immediately wash off with plenty of water. If the paste comes into contact with the eyes or mouth, immediately wash the area with plenty of water and contact a doctor. Note that the alkaline inside the film remains active for about 10 minutes after the picture has been printed.

■ Cautions on Handling the Film and Prints

For details, refer to the instructions and warnings on the packaging of the FUJIFILM Instant Film "instax mini".



Bluetooth® Devices: Cautions

IMPORTANT: Read the following notices before using the product's built-in Bluetooth transmitter.

■ **Use only as part of a Bluetooth network.**

FUJIFILM does not accept liability for damages resulting from unauthorized use. Do not use in applications requiring a high degree of reliability, for example in medical devices or other systems that may directly or indirectly impact human life. When using the device in computer and other systems that demand a greater degree of reliability than Bluetooth networks, be sure to take all necessary precautions to ensure safety and prevent malfunction.

■ **Use only in the country in which the device was purchased.**

This device conforms to regulations governing Bluetooth devices in the country in which it was purchased. Observe all location regulations when using the device. FUJIFILM does not accept liability for problems arising from use in other jurisdictions.

■ **Wireless data (images) may be intercepted by third parties.**

The security of data transmitted over wireless networks is not guaranteed.

■ **Do not use the device in locations subject to magnetic fields, static electricity, or radio interference.**

Do not use the transmitter in the vicinity of microwave ovens or in other locations subject to magnetic fields, static electricity, or radio interference that may prevent reception of wireless signals. Mutual interference may occur when the transmitter is used in the vicinity of other wireless devices operating in the 2.4 GHz band.

■ **The Bluetooth transmitter operates in the 2.4 GHz band.**

The maximum radio-frequency power is 6.79 mW.

■ **This device operates on the same frequency as commercial, educational, and medical devices and wireless transmitters.**

It also operates on the same frequency as licensed transmitters and special unlicensed low-voltage transmitters used in radio-frequency identification tracking systems for assembly lines and in other similar applications.

■ **To prevent interference with the above devices, observe the following precautions.**

Confirm that the radio-frequency identification transmitter is not in operation before using this device. If you notice that this device causes interference in low-voltage radio-frequency identification tracing systems, contact a FUJIFILM representative.

■ **The following may be punishable by law:**

- Disassembly or modification of this device.
- Removal of device certification labels.

■ **Trademark Information**

The Bluetooth® word mark and logos are registered trademarks owned by the Bluetooth SIG, Inc., and any use of such marks by FUJIFILM is under license.

Information for traceability in Europe**Manufacturer: FUJIFILM Corporation**

7-3, Akasaka 9-Chome, Minato-ku, Tokyo
Japan

Authorized representative in Europe:**FUJIFILM Europe GmbH**

Balcke-Duerr-Allee 6, 40882 Ratingen
Germany

EU Importer: FUJIFILM Europe B.V.

Oudenstaart 1, 5047 TK Tilburg
The Netherlands

UK Importer: FUJIFILM UK Limited

Fujifilm House, Whitbread Way,
Bedford, Bedfordshire, MK42 0ZE
UK

If you have any inquiries about this product, please contact a FUJIFILM authorized dealer, or access the website below.
<https://global.fujifilm.com/>

FUJIFILM

FUJIFILM Corporation

7-3, AKASAKA 9-CHOME, MINATO-KU, TOKYO 107-0052, JAPAN